

MEASUREMENT & ANALYTICS | DATA SHEET

ABB Ability™ Verification for measurement devices

SRV500 Standard/Enhanced

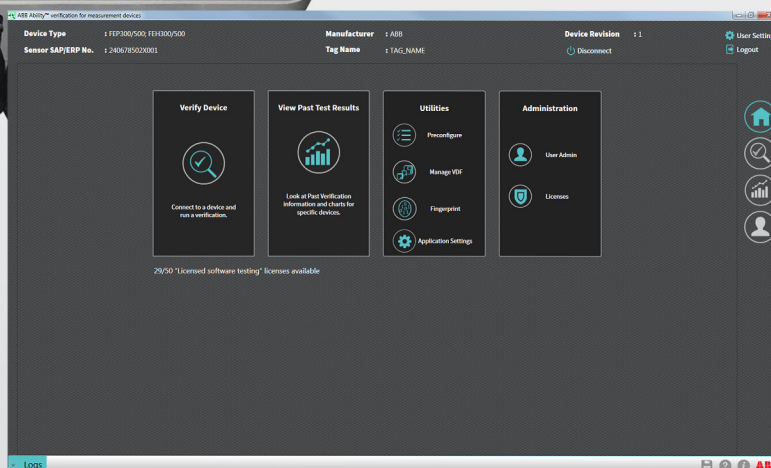

Measurement made easy

The best possible check of measurement performance, without removal from the process

Maintenance made easy

- universal test platform
- automated test procedure
- simple connection
- intuitive and easy-to-use software
- enhance your verification with an externally traceable input/output test

Predictive maintenance

- detailed analysis of device health status
- trend data to determine maintenance interval

Flexible license options to suit your needs

- try before you buy
- pay per use or annual licenses

Help meet regulatory requirements and reduce maintenance costs with verification testing

What is verification?

Verification is the inspection and testing of a measurement device to establish that it is functioning within a specified permissible measurement error. Verification is typically used to meet regulatory/quality management system requirements. Industrial instrumentation is robust, very reliable and designed to operate for many years with minimal maintenance. In today's competitive environment customers are looking for ways to maximize their profitability – regular product verifications is one way to ensure processes operate continuously at their peak. Verification can also increase calibration intervals, saving money and reducing downtime.

The ABB verification story

Customers in water and other industries have been able to save large sums of money thanks to ABB's innovations in product verification over the last two decades.

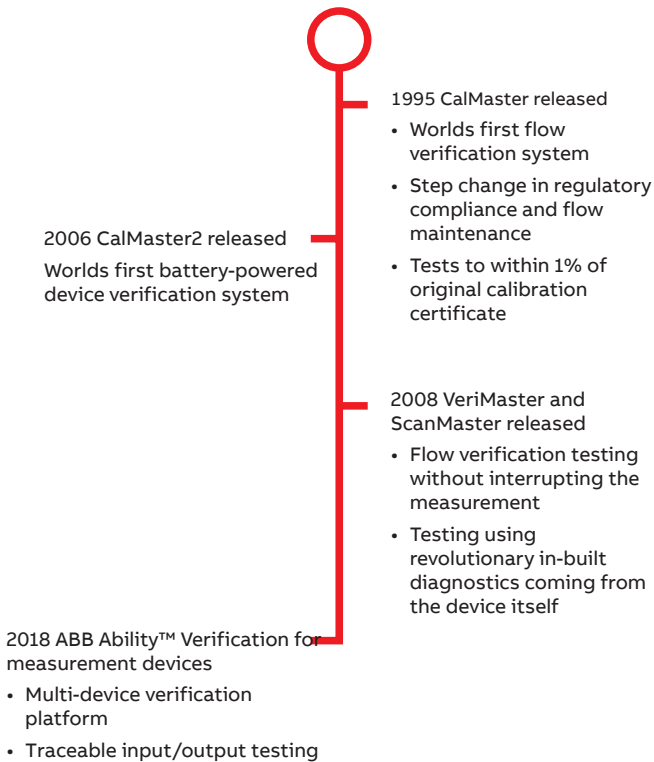

Introducing ABB Ability Verification for measurement devices

ABB Ability Verification for measurement devices is the next generation verification tool suite for use with a range of ABB devices. Download the software and load the relevant Verification Definition File (VDF) to provide the best possible check of measurement accuracy, without stopping your process.

The software (SRV500S) verifies the condition and performance of the device under test. With the licensed software version, test reports can be generated and stored locally for further analysis. Results can also be compared with historical measurements using the trending function.

For customers that require a traceable input/output test for regulatory/safety purposes the software can also be connected to a hardware testing unit SRV500H. SRV500H provides a plug-and-play, simple-to-use alternative to carrying a multimeter, precision resistor and timer counter into the field, with results included automatically in the verification report.

Building on ABB's fingerprint philosophy, each device is verification tested before shipping from the factory. The software enables the operator to choose whether to use either the factory fingerprint or to create a new fingerprint based on real site conditions after product commissioning. All verifications performed in the field can then be compared with the fingerprint data and previous tests to ensure device performance has not degraded.

Taking the pain out of instrumentation maintenance

- The clean, easy to use, software interface designed for keyboard and touch screen operation.
- Built-in help commands to walk the user through the verification process.
- Plug-and-play I/O tester



Snapshot of product features and verification levels



Enhanced

- Licensed software testing included
- Automated verification of outputs (pulse and current)
- USB input/output tester hardware box
- Accuracy statement for tested inputs and outputs

Unblocked features



Standard

- Instrument diagnostics verification
- Guided (manual) output testing
- Report generation
- Historical Verification Data (trending)
- Installable software for control systems

Blocked features



Basic

- Installable App (Windows 10)
- Device Health Indication pass/fail

Expanding functionality



Basic verification (try before you buy)

- A simple method of checking product health
- Simple connection to your device
- One-button testing
- Fast feedback of device condition

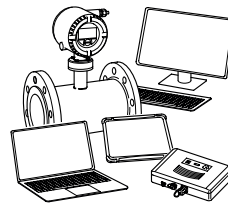
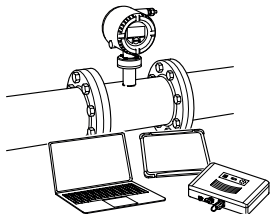

Enhanced verification

- Enhance your verification with an externally traceable input/output test
- Plug-and-play hardware tester

Standard verification (licensed software)

- Easy-to-operate testing of product performance and maintenance needs
- Detailed certificate printing for regulatory and quality system management
- Move from reactive- to predictive-maintenance planning with historical data analysis

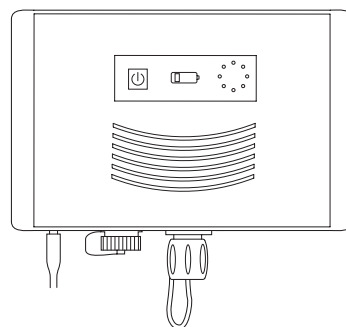

Ease of operation

The ease of operation of the software is of real benefit to the user, providing a list of verifications and the status of each device. Regardless of which type of device you are testing the results are stored in the same format for ease of use.

Certificates can be printed via the software in Adobe® .pdf format.

Condition monitoring

A major benefit is that the software can also be used as a diagnostic- and condition-monitoring tool. It stores all measured values automatically and includes visualization in a graph to enable long-term trend analysis.

Moving from preventive to predictive maintenance methodology

Detailed observation can give early warning of a possible system failure, enabling maintenance engineers to anticipate problems and take planned remedial action in advance.

Proof test coverage for ProcessMaster 300/500

Performing SRV500 verification results in >50 % diagnostic coverage identifying undetected failures. If the test is not passed, the device may no longer be used as part of a protective system.

The influence of systematic faults on the safety function are not covered by the test and must be examined separately. Systematic faults can be caused by, for example, medium properties, operating conditions, build-up or corrosion.

Proof test coverage for ProcessMaster FEP630

An on-site test, performed using SRV500 results in a >80 % diagnostic coverage identifying undetected failures.

An on-site inspection includes:

- visual inspection
- simulation and electrical inspection of the current output
- switching off and on
- performing a Fingerprint Verification – see Safety Instruction [SM/FEX630/SIL-EN](#)

Proof test coverage with activated VeriMass on FCB100/400

Factory calibration is the most complex and costly, but provides the greatest testing depth. In this case the user removes the flowmeter and sends it to the manufacturer for review and recalibration. Less costly on-site calibration with a reference device allows for limited testing depth. Using the VeriMass diagnostic procedure, together with onsite inspections, greatly simplifies and speeds calibration. It also makes possible testing depths of >90 % at very little expense without the need for a 'proof test' recalibration either on site or at a test lab.

Note.

A White Paper is available: [WP/CORIOLIS/VERIMASS/101-EN](#)
CoriolisMaster mass flowmeter | Diagnostics, verification and proof test.

Software interfaces

ABB Ability Verification for measurement devices is a versatile software platform that allows the customer to choose how they want to use it:

- local data storage
- pay-per-use licenses or annual
- multi-product testing or single product
- factory fingerprint or as commissioned

Specification – software

Microsoft™ Windows OS

- 10 enterprise

Supported communication protocols

- HART™
- Logic HART
- NFC
- IR
- Serial

Software language

English

Supported hardware

- Any laptop/Desktop machine
- Microsoft surface tablet

Hardware tester compatibility

The hardware tester is compatible only with the following transmitters:

- Standard/Basic/Enhanced versions:
 - FEP 300/500 ProcessMaster/HygienicMaster
 - FEX 100 WaterMaster
 - FET6XX ProcessMaster/HygienicMaster
 - AquaMaster2, AquaMaster3, AquaMaster4, MagMaster
 - AquaMaster4 MobileComms (4G & NB-IOT)
 - Hybrid: AquaMaster4 (Transmitter) + AquaMaster3 (Sensor)
 - Hybrid: ProcessMaster (Transmitter) + MagMaster (Sensor)
 - EMF Z Series (FEW010)
 - AquaProbe
 - LMT100
 - LLT100
 - TTX300
 - 266 PdP
 - CoriolisMaster
 - FSV430/FSS430
 - FSV450/FSS450
 - SensyFlow HART FMT500
 - FMT2XX/4XX
 - LWT300
 - EDP300
 - Hybrid: AquaMaster4 (Transmitter) + AquaMaster3 (Sensor)
 - Hybrid: FEP630/610/PM300/PM500 (Transmitter) + XE/XM (Sensor)
 - Hybrid: FEP630/610 (Transmitter) + PM300/PM500 (Sensor)
 - EMF Z Series (FEW010)
 - FSM400
 - Hybrid: AquaMaster4 (Transmitter) + AquaMaster3 (Sensor)
 - EMF Z Series (FEW010)
 - Hybrid: FEP630/610/PM300/PM500 (Transmitter) + XE/XM (Sensor)
 - Hybrid: FEP630/610 (Transmitter) + PM300/PM500 (Sensor)

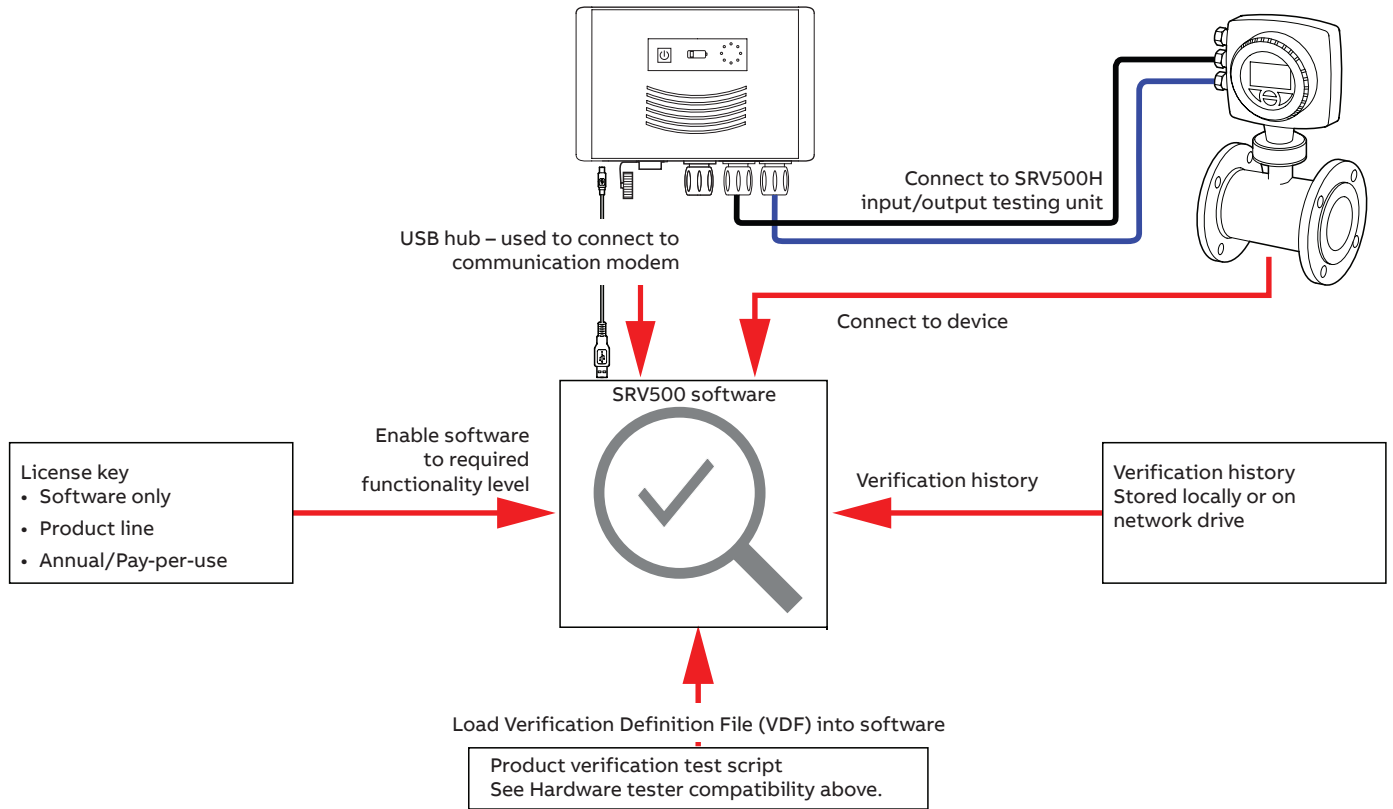

Specification – SRV500H hardware unit

SRV500H input/output test tool

Test capability

- mA outputs (active and passive) and mA inputs
- pulse or frequency outputs (active and passive)
- current input
- digital input
- supply voltage (10 or 24 V) communication protocols

Connection to PC/software

Connection via USB 2.0 or micro USB

Connection to instrument under test

Connection can be direct from the software-hosted PC or via the SRV500H unit

Power options

- battery powered
- battery powered and trickle charged via USB 2.0 connection to PC replacement battery option available to ensure testing can continue if power is depleted from the battery
- battery capacity allows for ten hours continuous use
- field-replaceable battery as an option

SRV500H is controlled by the software and enables the user to visualize SRV500H device connection status, battery charging/discharging, battery percentage. Additionally capability to control charging can be enabled and disabled in the software depending on users preference and battery status.

Status indicators

SRV500H device itself also includes LED indicators to advise operation status:

- device connected
- under test (Verification in Progress)
- SRV500H power ON indicator
- battery condition, good, charging, depleted

Calibration of SRV500H

To ensure the testing of the inputs and outputs remain traceable the tool requires annual calibration by an ABB Measurement & Analytics service workshop

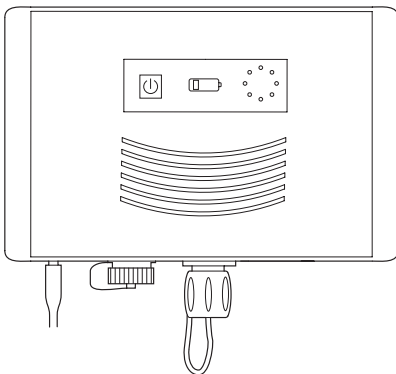

USB adaptor housing requirements

- housing material: ASA+PC
- all exposed metal made from 316L stainless steel to avoid corrosion
- housing dimensions: 280 × 170 × 60 mm (11.02 × 6.69 × 2.36 in)
- weight: 1200 g (2.74 lb)
- adaptor fits into a toughened plastic case for transportation

Accuracy of input/output requests

Measurement	Measurement range	Measurement accuracy
Current output (active/passive)	4 to 20 mA	±0.05 % of range
Pulse output (active/passive)	0.1 to 11 KHz	±2 % reading
Internal temperature	20 to 60 °C	±1 deg. C
Current input	4 to 20 mA	±0.05 % of range (20 ppm)
Digital output (active/passive)	>5 V and <24 V	Low or High
Digital input	24 V	±2 %
Supply voltage	10 to 24V	±2 %

The SRV500H is hot-pluggable to the PC and to the software without the need for special connection/disconnection means

Environmental specification







- IP65 as standard
- ambient temperature range Std. : -20 to 60 °C (-4 to 140 °F)
- storage temperature: -40 to 70 °C (-40 to 158 °F)
- relative humidity: 5 to 95 % non-condensing
- Sinusoidal vibrations: according to DIN EN 60068-2-6/IEC 60068-2-6.
- vibration transport condition shock: according to DIN EN 60068-2-27/IEC 60068-2-27
- impact tests (IK5) and drop tests in accordance with IATA dropped from 1.2 m (3.93 ft) height

CE mark

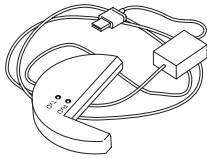
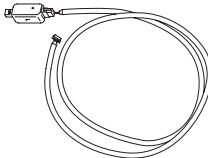
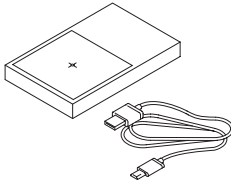
EMC

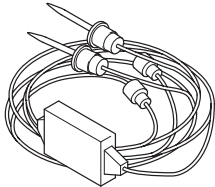
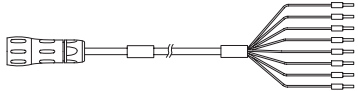
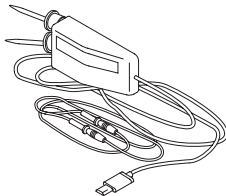
- EMC Directive 2014/30/EU
- EMC Standard DIN EN 61326-1/IEC 61326
- EMC Standard DIN EN 61326-2-3/IEC 61326-2-3
- RoHS Directive 2011/65/EU

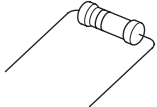
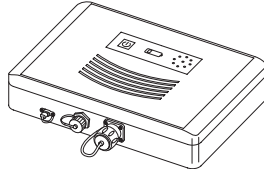
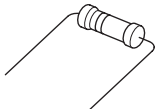
Accessories list

Part number	Description	Part number	Description
FZA100	Infrared service port adapter	3KXS360040L0003	Local operating interface for 4-WCT
			
3KXS210059L0001	FEIG™ NFC reader	3KXS210051L0001	AquaMaster4 cable
			
3KXS210058L0001	Mactek HART modem	3KXS210052L0001	Common cable for I/O testing of ProcessMaster/HygienicMaster/WaterMaster
			
3KXS210057L0001	IFAK HART modem	3KXS210053L0001	USB cable: USB 2.0, type A to Micro B
			
3KXS210013L0001	1000 Ω resistor (pulse)	3KXS210010U0100	Verification tester (enhanced)
			
3KXS210012L0001	250 Ω ±0.05 % resistor (current out)	3KXS210025L0001	Battery (Li-ion, 3.7 V, 5.8 Ah)
			

Supported products

ProcessMaster



FEP300
For efficient plant operation and constant product quality



FEP500
For efficient plant operation and constant product quality with extended diagnosis functionality



FEP610
The first choice for all industrial standard applications



FEP630
Innovative next generation of electromagnetic flowmeters with SmartSensor technology and built-in verification

HygienicMaster



FEH300
For demanding hygienic applications



FEH500
For demanding hygienic applications with extend diagnosis functionality



FEH610
The first choice for all industrial standard applications



FEH630
Designed to meet highest levels of demands for enhanced metering with SmartSensor technology and built-in verification

WaterMaster



WaterMaster
Measurement/management in water, waste water and effluent applications

AquaMaster4



AquaMaster4
The ideal flowmeter for potable water distribution networks, revenue metering and irrigation applications

AquaMaster3



AquaMaster3
The high value, precision solution for remote water metering and irrigation applications

AquaMaster2



AquaMaster2
Designed to improve the management of potable water distribution networks, AquaMaster 2's integral multi-speed, multi-channel, dual variable data logger improves the precision and quality of logged information.

SwirlMaster



FSS430
The basic version of swirl flowmeters for measurement of gases, liquid and steam

FSS450



FSS450
The universal version of swirl flowmeters with enhanced flow computer functionality for gases, liquid and steam

VortexMaster



FSV430
The basic version of vortex flowmeters for measurement of gases, liquid and steam

FSV450



FSV450
The universal version of vortex flowmeters with enhanced flow computer functionality for gases, liquid and steam

CoriolisMaster



CoriolisMaster
For accurate flow and density measurement of liquids and gases, low pressure drop, high capacity

MagMaster



MagMaster
Over three quarters of a million of ABB's hugely successful MagMaster flowmeter have been sold worldwide. MagMaster was replaced in late 2012 by the feature-rich WaterMaster and AquaMaster ranges

AquaProbe



AquaProbe
An economic alternative to full bore flowmeters, AquaProbe FEA finds application in existing water distribution systems where a full bore flow meter would be uneconomic

FMT2XX/4XX



FMT2XX/4XX
Thermal mass flowmeters that are suitable for all industrial and test rig applications demanding quick and precise gas measurement

LMT100



LMT100
A modular range of field mounted, advanced microprocessor-based electronic transmitters, utilizing multiple sensor technologies

LLT100



LLT100
The LLT100 is a high performance laser transmitter that accurately measures level, distance and position over short and long ranges

TTX300



TTX300
A range of compact and robust field mounted temperature transmitters accommodated in field housings with optional indicators

266PdP



266XXX
Pressure transmitters offering a broad variety of communication possibilities

LWT300



LWT300
Guided-wave radar level transmitters with built-in intelligence to differentiate between the actual level and other false signals

EDP300



DP300
An electronically configurable positioner with communication capabilities designed for mounting to linear or rotary actuators.

FSM4000



FSM4000
A robust flowmeter for heavy duty applications.

EMF Z Series (FEW010)



EMF Z Series (FEW010)
WaterMaster is the ultimate solution for flow measurement and management in sectors as diverse as water, waste water, sewage and effluent.

AquaMaster 4



AquaMaster 4 Mobile comms
AquaMaster is the ultimate solution for flow measurement for District Metered Area. Measuring every drop accurately.



Acknowledgments

- ABB Ability is a registered trademark of ABB Limited.
- Microsoft is a registered trademark of Microsoft Corporation in the United States and/or other countries.
- Windows and Windows 10 are all registered trademarks of Microsoft Corporation in the United States and/or other countries
- Adobe is a registered trademark of Adobe Systems Incorporated in the United States and/or other countries
- HART is a registered trademark of the FieldComm Group.
- MacTek is a registered trademark of WIKA Instruments Ltd.
- FEIG is a registered trademark of FEIG ELECTRONIC GmbH.

Flow verification services



Advanced services



ABB Ability Verification for measurement devices







ABB Limited

Measurement & Analytics
Peenya Industrial Area
Bangalore-560058
India
Toll free: 1800 420 0707
International: +91 80 67143000
Email: contact.center@in.abb.com

ABB Inc.

Measurement & Analytics
125 E. County Line Road
Warminster
PA 18974
USA
Tel: +1 215 674 6000
Fax: +1 215 674 7183

abb.com/measurement-verification

ABB Limited

Measurement & Analytics
Oldends Lane, Stonehouse
Gloucestershire, GL10 3TA
UK
Tel: +44 (0)1453 826 661
Fax: +44 (0)1453 829 671
Email: instrumentation@gb.abb.com

ABB Engineering (Shanghai) Ltd.

Measurement & Analytics
No. 4528, Kangxin Highway
Pudong New District
Shanghai, 201319
P.R. China
Tel: +86(0) 21 6105 6666
Fax: +86(0) 21 6105 6677
Email: china.instrumentation@cn.abb.com

We reserve the right to make technical changes or modify the contents of this document without prior notice. With regard to purchase orders, the agreed particulars shall prevail.
ABB does not accept any responsibility whatsoever for potential errors or possible lack of information in this document.

We reserve all rights in this document and in the subject matter and illustrations contained therein. Any reproduction, disclosure to third parties or utilization of its contents – in whole or in parts – is forbidden without prior written consent of ABB.